

FIG. 1

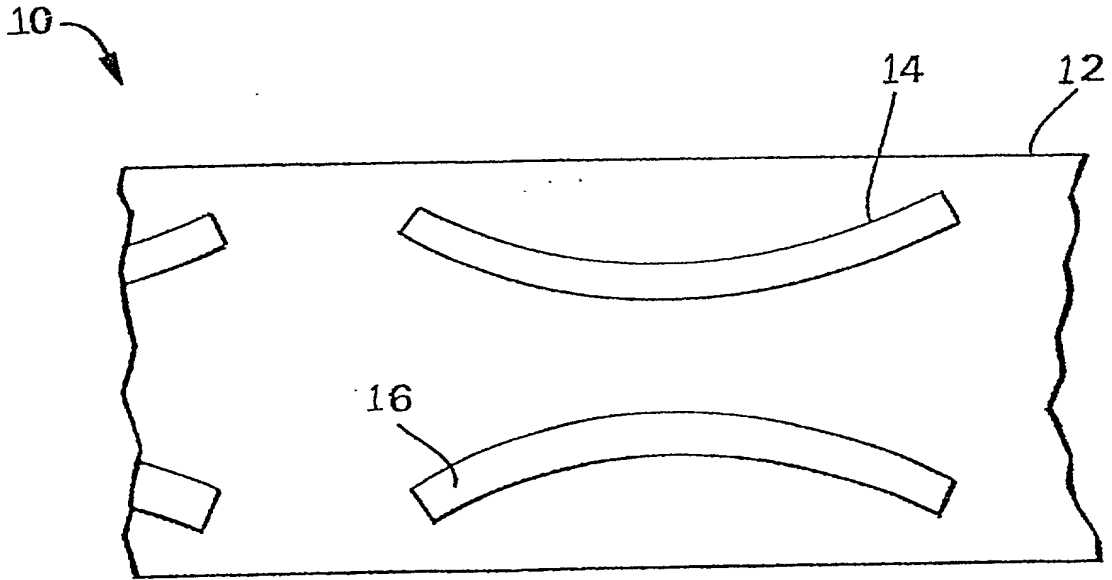

FIG. 1

FIG. 2

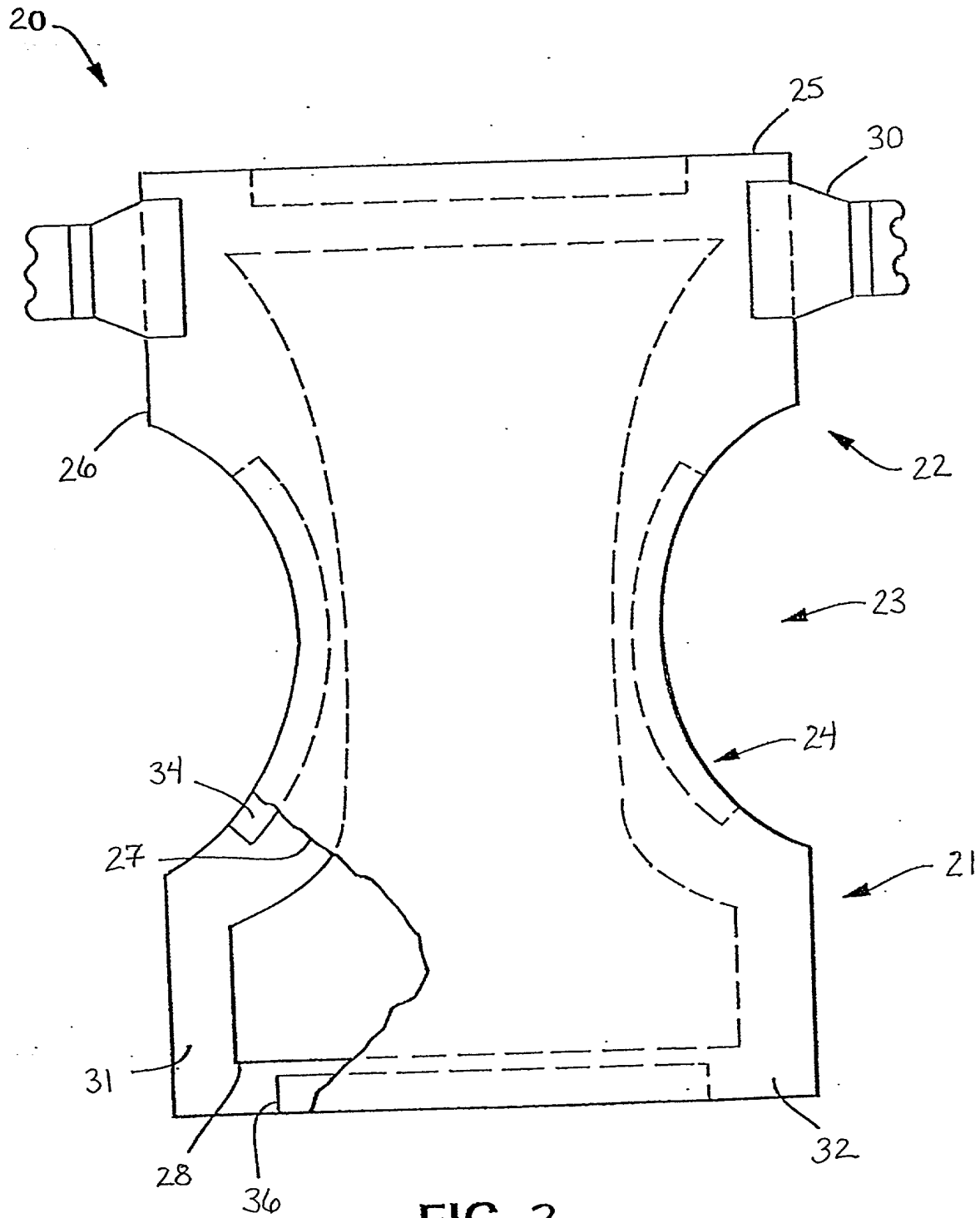

FIG. 2